

HEAVY DUTY CONCEALED HINGE (INSET)



J95-24/0T, J95-C24/0T

HINGES

HEAVY DUTY CONCEALED HINGES (INSET)



Nickel (NI)



Black Nickel (BN)

- Load capacity: 25 kg (55 lbs)/2 pcs, 40 kg (88 lbs)/3 pcs.
- Maximum door width: 800 mm (31-1/2")/2 pcs, 900 mm (35-7/16")/3 pcs.
- Clip on type for easy installation.
- 3-way adjustment with door installed.
- Requires 6 M5 or equivalent (US#10) screws: 2 pcs for each hinge, and 4 pcs for each mounting plate.
- Optional hinge cover (J95SC-0) and mounting plate cover (J95ZC) available (sold separately p.288).
- For glass door applications, see page 287.

Wood Door Application

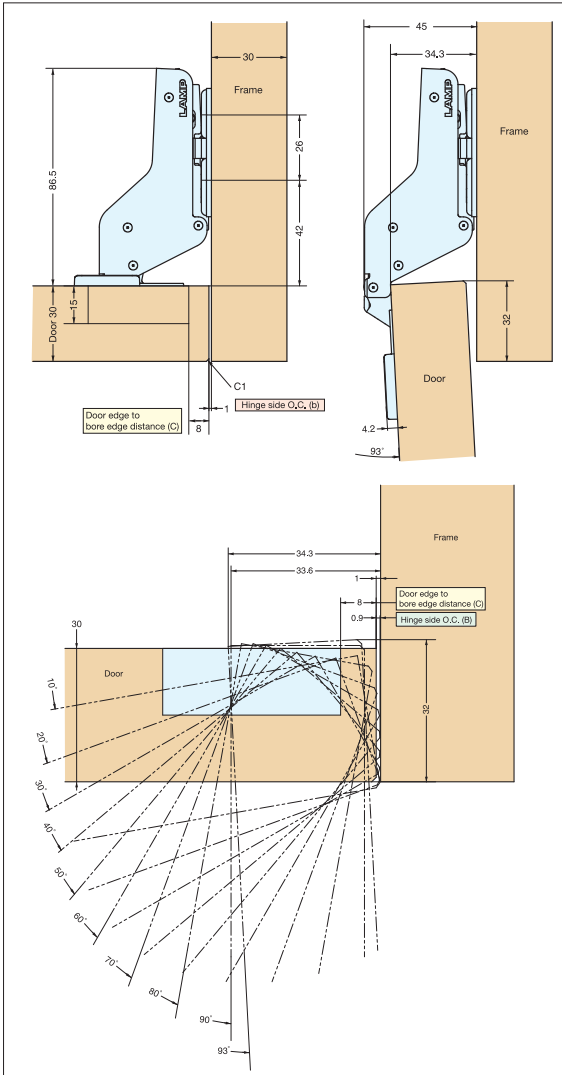

MOUNTING PLATE J95-P6T

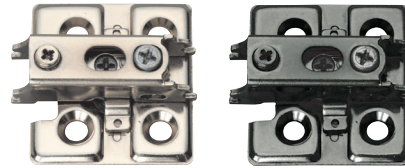

Nickel (NI)

Black Nickel (BN)

Mounting Plate sold separately. See page 288 for more details

Item No.	Finish	Weight (g)	Material
J95-P6T-NI	Nickel	94	Steel/Zinc Alloy
J95-P6T-BN	Black Nickel		

■ Door edge to bore edge distance (C) and Hinge side O.C. (b)

Table 1.

Door edge to bore edge distance (C)	3	4	5	6	7	8
Hinge side O.C. (b)	6	5	4	3	2	1

■ Hinge side opening clearance chart

Table 2.

Door thickness (D)*	Door edge to bore edge distance (C)					
	3	4	5	6	7	8
18	0	0	0	0	0	0
20	0	0	0	0	0	0
22	0.1	0.1	0.1	0.1	0.1	0.1
24	0.1	0.1	0.1	0.1	0.1	0.1
26	0.3	0.3	0.3	0.3	0.3	0.3
28	1.7	1.1	0.6	0.5	0.5	0.5
30	3.5	2.9	2.3	1.8	1.0	0.9
32	5.4	4.7	4.1	3.6	3.0	2.5
34	7.3	6.0	6.0	5.4	4.8	4.3

Hinge side O.C. (B)

*If the door thickness is over 30 mm (1-3/16") the door will need to be chamfered.

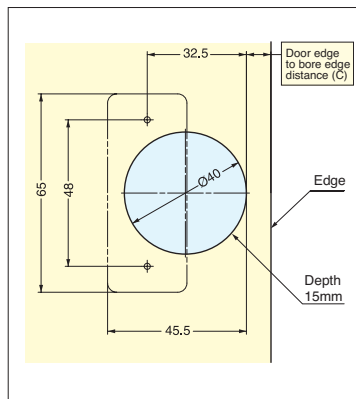

Bore Dimensions



MOUNTING PLATE COVER (J95ZC-GR/NI/BC) and SAFETY COVER (J95SC-0GR/NI/BC)

Sold Separately Available in Grey (GR), Nickel (NI) and Black Chrome (BC) See p.288

Item No.	Type	Weight (g)	Box (pcs)	Carton (pcs)	Finish
J95-24/0T-NI	Free Swing	148	10	50	Nickel (NI)
J95-C24/0T-NI	Self-Closing	160			
J95-24/0T-BN	Free Swing	148			Black Nickel (BN)
J95-C24/0T-BN	Self-Closing	160			

Part Name	Material
Cup	Zinc Alloy
Body	Steel

*Requires J95-P6T Mounting Plate (sold separately p.288).

HEAVY DUTY CONCEALED HINGE (INSET)



J95-24/0T, J95-C24/0T

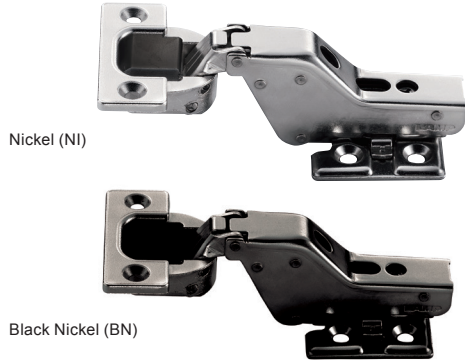

Nickel (NI)

Black Nickel (BN)

- Load capacity: 25 kg (55 lbs)/2 pcs, 35 kg (77 lbs)/3 pcs.
- Maximum door width: 800 mm (31-1/2")/2 pcs.
- Recommended door thickness: 8~10mm (5/16~3/8) for tempered glass only.
- Clip on type for easy installation.
- 3-way adjustment with door installed.
- Requires 6 M5 or equivalent (US#10) screws: 2 pcs for each hinge, and 4 pcs for each mounting plate.
- Optional hinge cover (J95SC-0) and mounting plate cover (J95ZC) available (sold separately p.288).
- Glass face plate (GH-J95FP) also available (sold separately p.289).
- For wood door applications, see page 286.

Glass Door Application

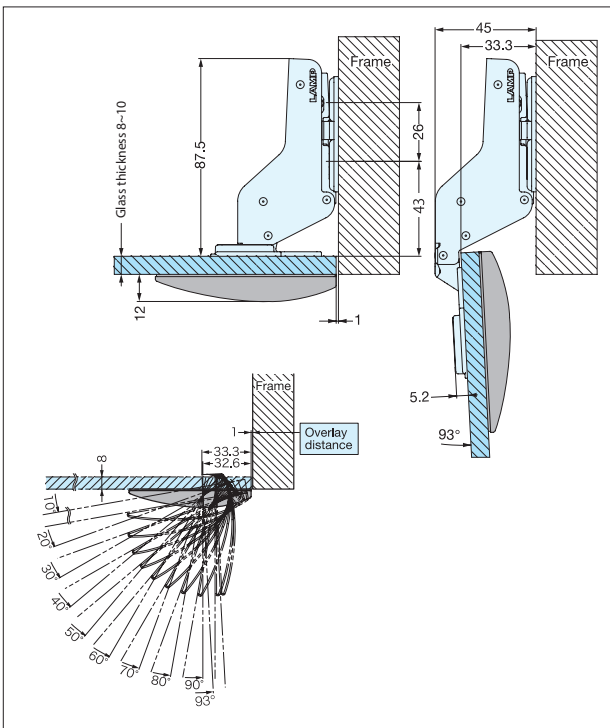

MOUNTING PLATE J95-P6T

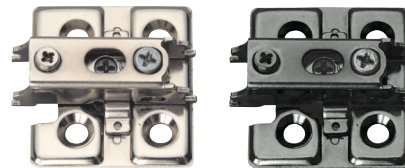

Mounting Plate sold separately. See page 288 for more details

Nickel (NI)

Black Nickel (BN)

Item No.	Finish	Weight (g)	Material
J95-P6T-NI	Nickel	94	Steel/Zinc Alloy
J95-P6T-BN	Black Nickel		

Hinge side opening clearance chart

Glass thickness (D)	Hinge side O.C.
8	0
9.5 (3/8")	0
10	0

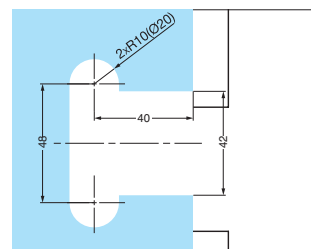
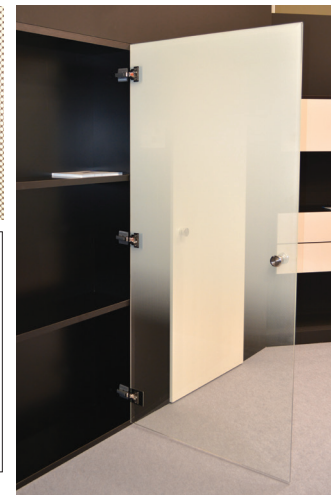

Bore Dimensions

■ Glass thickness 8 mm

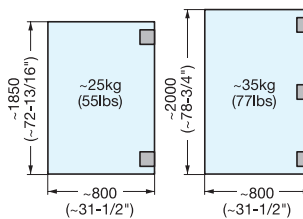

■ Glass thickness 10 mm

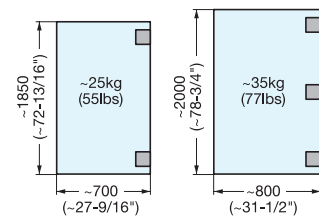

Chrome (CR)

Satin Nickel (SN)

Black (BL)

GH-J95FP/CR/SN/BL
Glass Face Plate
Sold Separately
(See p.289)



Grey (GR)

Nickel (NI)

Black Chrome (BC)

J95ZC-GR/NI/BC
Mounting Plate Cover
Sold Separately
(See p.288)



Grey (GR)

Nickel (NI)

Black Chrome (BC)

J95SC-0GR/NI/BC
Safety Cover
Sold Separately
(See p.288)

Item No.	Type	Weight (g)	Box (pcs)	Carton (pcs)	Finish
J95-24/0T-NI	Free Swing	148	10	50	Nickel (NI)
J95-C24/0T-NI	Self-Closing	160			
J95-24/0T-BN	Free Swing	148			
J95-C24/0T-BN	Self-Closing	160			

Part Name	Material
Cup	Zinc Alloy
Body	Steel

*Requires J95-P6T Mounting Plate and GH-J95FP faceplate for glass door application (sold separately p.288-289).